

User's Guide



FSHD-4700



HIGH DEFINITION SET TOP BOX



Contents

GENERAL INFORMATION 3

Main Features	3
For your Safety	4
Unpacking	7
General Operation	7
RCU	8
Rear Panel	9

INSTALLATION 10

MENU INFORMATION 11

Main Menu	11
1. Edit Channel	12
1.1 TV Channel List	12
1.2 Radio Channel List	15
1.3 Delete channels by satellite	15
2. Installation	15
2.1 Antenna Connection	15
2.2 Satellite List	16
2.3 Antenna Setup	17
2.4 Single Satellite Search	19
2.5 Multi Satellite Search	19
2.6 TP List	20
3. System Setup	21
3.1 Language	21
3.2 TV System	22
3.3 Display Setting	22
3.4 Local Time setting	22
3.5 Timer Setting	23
3.6 Parental Lock	23
3.7 OSD Setting	24
3.8 Favorite	24
3.9 Other	24

Contents

4. Tools	24
4.1 Information	24
4.2 Factory Setting	25
4.3 Conditional Access	25
4.4 Upgrade by USB	26
4.5 Network Local Setting	26
4.6 WiFi Manager	26
4.7 Upgrade by Network	27
4.8 Weather Forecast	27
4.9 RSS Reader	27
5. Game	27
6. REC	27
6.1 Media Player	27
6.2 PVR Storage Information	28
6.3 PVR Setting	29
6.4 Remove USB device safely	29
7. Hot key	29
7.1 Info	29
7.2 EPG	29
7.3 Find	30
7.4 Number	30
7.5 TV/Radio	30
7.6 Up/Down	30
7.7 Left/Right	30
7.8 Mute	30
7.9 Pause	30
7.10 OK	30
7.11 Audio	31
7.12 Recall	31
7.13 Fav	31
7.14 Teletext	31

TROUBLE SHOOTING

32

GENERAL INFORMATION

A Digital Satellite Receiver is a convenient product that allows you to view a variety of programs provided through satellite. This user's guide covers the installation of the DSR and the necessary steps to implement various features. This also explains special features available only in this DSR in detail, which will allow you to make full use of these feature.

Information confirmed in this document is subject to change. We reserves the right, without notice, to make change in product design or performances as progress in engineering or technology .

Main Features

- MPEG2 SD, MPEG2 HD, H.264/A VC SD, H.264/A VC HD,MP4
- Embedded Conax
- SCPC and MCPC receivable from C/Ku band satellite
- Automatic PAL/NTSC conversion
- 4000 channels TV and Radio programmable
- 32 different favorite groups selection
- Multi-language OSD
- Fully support to 7 days Electronic Program Guide(EPG)
- Picture in Graphics(PIG) support
- True color On Screen Display
- Automatic network search for newly added transponders
- DiSEqC 1.2 fully support, 13/18V , 0/22K, LNB control
- Various channel editing functions(favorite, moving, locking, renaming, deleting and sorting)
- Parental control for channels
- Easy to use Menu System
- Software upgrades through RS232 port and Receiver to receiver , Support USB upgrade
- 8 Timer Reservations, automatically switch to a specific channel
- Subtitle support DVB EN300743 and EBU
- Teletext support DVB ETS300472 by VBI and OSD
- Automatic save for last channel
- Channel list can be sorted by alphabetic A-Z,Scramble,Favorite,Lock,Sat
- Support FA T16/FA T32/FA T12
- Only list JPEG/BMP files
- 480i/p, 576i/p, 720p, 1080i,1080p with HDCP copy protection
- Games
- 1 recording, then still can timeshift

GENERAL INFORMATION

For Your Safety

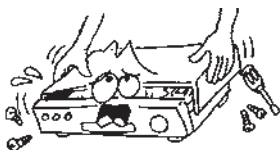

- To avoid electric-shock hazards, do not open the cabinet, refer servicing to qualified personnel only.



- Keep the receiver away from flower vases, tubs, sinks, etc., in order to avoid damaging the equipment.



- Do not expose the receiver under the sunlight. And keep it away from the heat source.

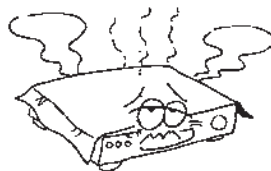

- Do not block ventilation holes of the Receiver so that air can circulate freely.

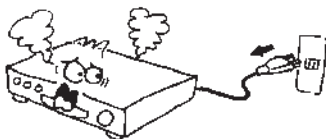

- When the abnormal phenomenon occurs, you should cut off the power immediately.

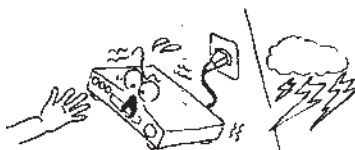

- Do not touch the receiver during thunder, since that might create electric-shock hazards.



- Switch the receiver off whenever it remains out of service for an extended period.

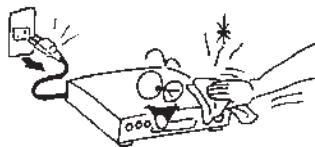

- Be sure to turn the Receiver off and disconnect the AC power cord before cleaning the Receiver surface. If the surface is dirty, wipe clean with a cloth which has been dipped in a weak soap-and-water solution and wrung out thoroughly, and then wipe again with a dry cloth.

GENERAL INFORMATION

IMPORTANT SAFETY INSTRUCTIONS

1. Read these instructions – All the safety and operating instructions should be read before this product is operated.
2. Keep these instructions – The safety and operating instructions should be retained for future reference.
3. Heed all warnings – All warnings on the appliance and in the operating instructions should be adhered to.
4. Follow all instructions – All operating and use instructions should be followed.
5. Do not use this apparatus near water – The appliance should not be used near water or moisture – for example, in a wet basement or near a swimming pool, and the like.
6. Clean only with dry cloth.
7. Do not block any ventilation openings. Install in accordance with the manufacture's instructions.
8. Do not install near any heat sources such as radiators, heat registers, stoves, or other apparatus (including amplifiers) that produce heat.
9. If the provided plug does not fit into your outlet, consult an electrician for replacement of the obsolete outlet.
10. Protect the power cord from being walked on or pinched particularly at the plugs, convenience receptacles, and at the point where they exit from the apparatus.
11. Only use attachments/accessories specified by the manufacturer.
12. Use only with the cart, stand, tripod, bracket, or table specified by the manufacturer, or sold with the apparatus. When a cart or rack is used, use caution when moving the cart/apparatus combination to avoid injury from tip-over.



13. Unplug the apparatus during lightning storms or when unused for long periods of time.
14. Refer all servicing to qualified personnel. Servicing is required when the apparatus has been damaged in any way, such as power supply cord or plug is damaged, liquid has been spilled or objects have fallen into the apparatus has been exposed to rain or moisture, does not operate normally, or has been dropped.
15. CAUTION: These servicing instructions are for use by qualified service personnel only. To reduce the risk of electric shock, do not perform any servicing other than that contained in the operating instructions unless you are qualified to do so.
16. Ensure that the ventilation is not impeded by covering the ventilation openings with items such as newspapers, table-cloth, curtains, etc.
17. WARNING: To reduce the risk of fire or electric shock, do not expose this apparatus to rain or moisture. The apparatus shall not be exposed to dripping or splashing and that objects filled with liquids, such as vases, shall not be placed on apparatus.
18. WARNING: For the terminals marked with symbol of “⚡” may be of sufficient magnitude to

GENERAL INFORMATION

constitute a risk of electric shock. The external wiring connected to the terminals requires installation by an instructed person or the used of ready-made leads or cords.

19. CAUTION: Danger of explosion if battery is incorrectly replaced. Replace only with the same or equivalent type.
20. WARNING: The battery (battery or batteries or battery pack) shall not be exposed to excessive heat such as sunshine, fire or the like.
21. WARNING: The mains plug is used as disconnect device, the disconnect device shall remain readily operable
22. Explanation of symbol, marking, signal lamp or similar means indicate that apparatus is completely disconnected from the mains.  This equipment is a Class II or double insulated electrical appliance. It has been designed in such a way that it does not require a safety connection to electrical earth.



23.

- This lightning flash with arrowhead symbol within an equilateral triangle is intended to alert the user to the presence of non-insulated "dangerous voltage" within the product's enclosure that may be of sufficient magnitude to constitute a risk of electric shock.

- Warning: To reduce the risk of electric shock, do not remove cover (or back) as there are no user-serviceable parts inside. Refer servicing to qualified personnel.

- The exclamation point within an equilateral triangle is intended to alert the user to the presence of important operating and maintenance instructions in the literature accompanying the appliance.



24:  Correct Disposal of this product. This marking indicates that this product should not be disposed with other household wastes throughout the EU. To prevent possible harm to the environment or human health from uncontrolled waste disposal, recycle it responsibly to promote the sustainable reuse of material resources. To return your used device, please use the return and collection systems or contact the retailer where the product was purchased. They can take this product for environmental safe recycling.

GENERAL INFORMATION

Unpacking (Optional)



● Remote Control



● Batteries



● User's Guide



● AV cable

General Operation

- Throughout this manual you will notice that the everyday operation of the receiver is based on a series of user friendly on screen display and menus. These menus will help you get the most from your receiver, guiding you through installation, channel organizing, viewing and many other functions.
- All functions can be carried out using the buttons on the RCU, and some of the functions can also be carried out using the buttons on the front panel.
- The receiver is easy to use, always at your command and adaptable for future advances.
- Please be aware that new software may change the functionality of the receiver.
- Should you experience any difficulties with the operation of your receiver, please consult the relevant section of this manual, including the Problem Shooting, or alternatively call your dealer or a customer service adviser.

GENERAL INFORMATION

RCU

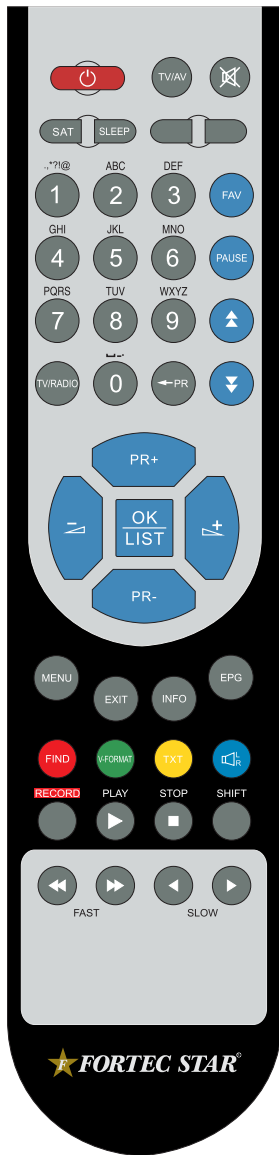

Key	Function
	Standby/On, Standby/Off
	When watching a channel, mute the sound
0~9	Enter number of the required menu item or select a channel number to watch
TV/RADIO	Switches between TV and Radio mode
← PR	Switches back to previous channel
FAV	Displays the favorite group list
SAT	Display the satellite window
FIND	Display the Find window
INFO	Show information of the current channel
MENU	Press this key one time to run menu onscreen
	Moves up / down a page in the list
OK, LIST	Executes the selected item in the menu screen or enters the desired value in any input mode
PR+, PR-	When watching a channel, change channels or move to the next higher or lower item in the menu
	When watching a channel, adjust the volume or move to the left or right item in the menu
EXIT	Return to the previous menu on the menu screen or escape from the menu
EPG	Call up the EPG (Electronic Program Guide)
	Display the Audio window.
SLEEP	Enter into the sleep in mode
TXT	Switch to teletext or subtitle mode
TV/AV	Switch between TV and AV modes
V-FORMAT	Changes the HD-Format
RECORD	Record the program
	Play and stop the program
	Press to fast forward or fast backward
	Press to slow forward or slow backward
SHIFT	Timeshift function key
PAUSE	Press once to pause the screen picture, press once again to go to the normal mode

GENERAL INFORMATION

Rear Panel

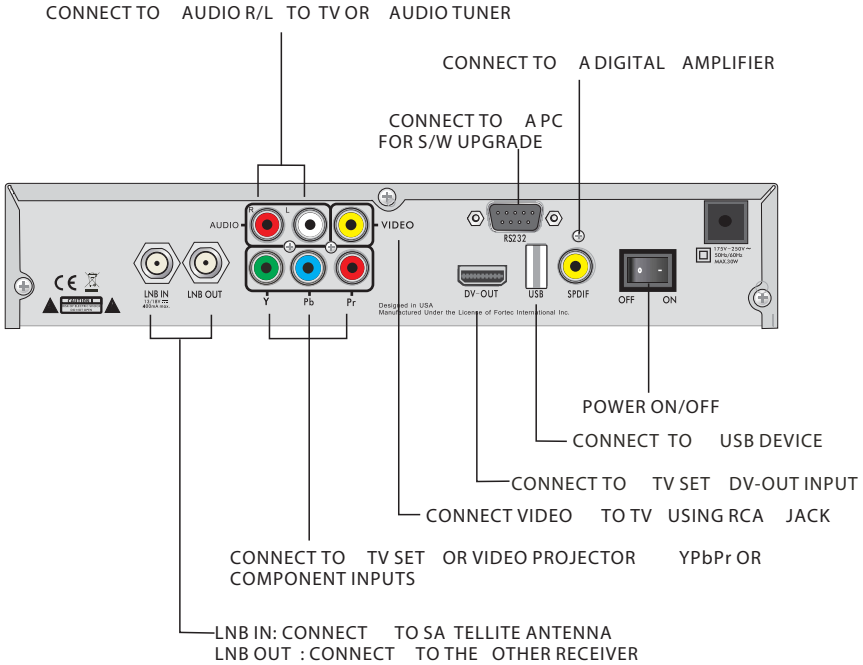

Connecting to TV using HDMI support

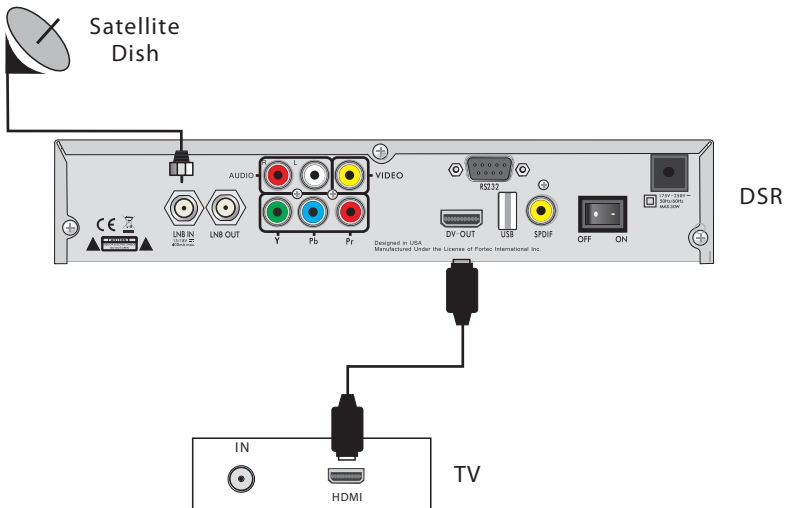

● The picture is only for reference, please make the object as the standard.

INSTALLATION

Connecting to TV using SCART support

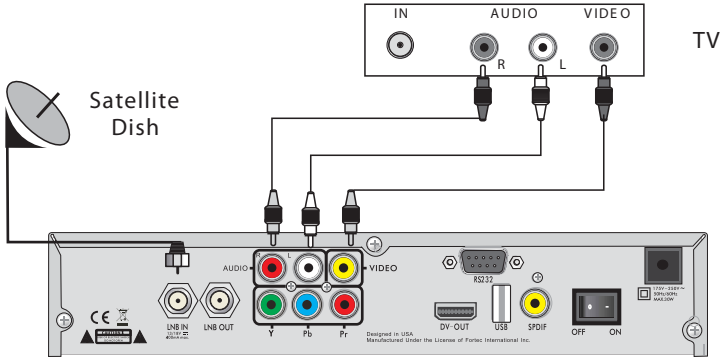

Connecting to Digital Amplifier

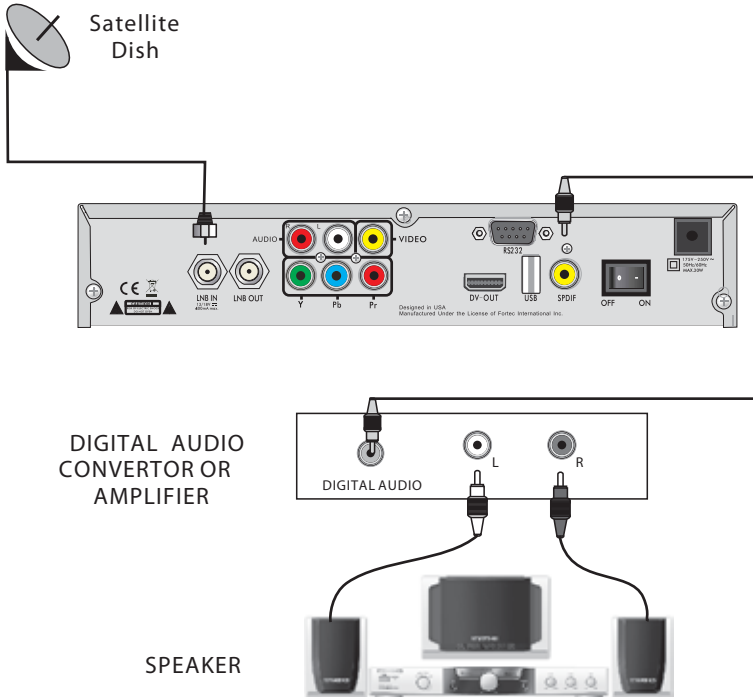

MENU INFORMATION

Main Menu

- Make sure that you have properly installed and connected the cables of the receiver . If the receiver is the factory status or there is no program list, when power on, the Main Menu window will be displayed on the screen.

During the normal TV/Radio mode, press MENU key on the RCU to enter into the Main Menu window.

- This menu consists of 6 major main menus as follow.

- Edit Channel
- Installation
- System Setup
- Tools
- Game
- REC



- During the installation the OK key confirms a selection and LIST key shows Down List Box if the column has mark. You can also use the numeric keys on the RCU to enter numeric value.

Use the PR+ , PR- key to move upwards and downwards from one line to another line and use \leftarrow \rightarrow key to move from main menu to sub menu and move from left side to right side or versa.

Meantime, you want to escape the menu system, please press MENU or EXIT key on the RCU.

MENU INFORMATION

- If there is no program, you can not exit from the Main Menu window by pressing MENU or EXIT key. System will inform "No channel" and the following items turn grey.

Sub-menu	Turn grey when there is no program
Edit Channel	TV Channel List Radio Channel List Delete channels by satellite
Installation	Antenna Connection Satellite List Antenna Setup Single Satellite Search Multi Satellite Search TP List
System Setup	Language TV System Local Time Setting Timer Setting Parental Lock OSD Setting Favorite Other Display Setting
Tools	Information Factory Setting Conditional Access Upgrade by USB Network Local Setting WiFi Manager Upgrade by Network Weather Forecast RSS Reader
Game	Othello Sudoku
REC	Media Player PVR Storage Information PVR Setting Remove USB device safely

1. Edit Channel

1. Press OK key or \leftarrow key to pop up the "Input Password" dialogue, you can not enter into the menu unless the correct password is inputted. The default password is " 0000".
2. Press PR+, PR- keys to move the cursor up or down.
3. Press EXIT key or \rightarrow key to move the focus to the left menu.



1.1 TV Channel List

1. Press \rightarrow keys to select satellite.
2. Press PR+, PR- keys to select the program that you want to play, and then press OK key to view it in the small window. If move the yellow cursor to select up or down, you will see a gray line which indicates the playing program in the small window.



MENU INFORMATION

3. Press FAV key to move the FAV button upward. Select the program and press OK key to pop up the favourite group list. In the list, select the group that you want to add into and press OK key, and then you will find the favourite mark is displayed at the right side of the selected program.

Press FAV key again to exit from the fav mode, and you will find the FAV button return to the origin position.



4. Press red colour key to move the Lock button upward. Select the program and press OK key to mark this program with the Lock mark. You can cancel this mark by pressing OK key once more.

Press red colour key again to exit from the lock mode, and you will find the Lock button return to the origin position.



5. Press green colour key to move the Skip button upward. Select the program and press OK key to mark this program with the skip mark. You can cancel this mark by pressing OK key once more.

Press green colour key again to exit from the skip mode, and you will find the Skip button return to the origin position.



6. Press yellow colour key to move the Move button upward. Select the program and press OK key to mark this program with the move mark. Press PR+, PR- keys to move the cursor to the position where you want to locate and press OK key to confirm.

Press yellow colour key again to exit from the yellow mode, and you will find the yellow button return to the origin position.



7. Press blue colour key to enter into the Edit channel window.



MENU INFORMATION

i. Sort (red colour key)

Press red colour key to pop up the Sort drop-down list.

Name(A-Z): The ascending order, omitting the \$ character, the number is ahead, then the capital letter, at last the lowercase.

Name (Z-A): The opposite order of the above Name (A-Z).

Free/Scramble: All FT A programs are listed ahead, while all scrambled programs are listed last.

Lock: all locked programs are listed at the last.



ii. Edit (green colour key)

Press green colour key to move the Edit button upward. Select the program and press OK key to pop up the Rename window.

In Rename window, press red colour key to switch between capital letter and lower letter; press green colour key to delete the character on the cursor; press ← → keys to move the cursor left or right; press numeric keys (0-9) to input the character, please refer to the down table. Press yellow colour key to save and exit, or press blue key to cancel and exit.



Numeric keys	Press numeric key repeatedly, display in circle
1	.,*?!@1
2	ABC2
3	DEF3
4	GHI4
5	JKL5
6	MNO6
7	PQRS7
8	TUV8
9	WXYZ9
0	[space]_-0

If the name is empty, system will pop up a dialogue informing "Name" once yellow colour key is pressed. Press OK key to close this dialogue.

MENU INFORMATION

iii. Delete (blue colour key)

In Delete window, press blue colour key to move the Delete button upward. Select the program and press OK key to mark this program with the deletion mark. You can cancel this mark by pressing OK key again.

Press EXIT key to pop up the dialogue "Are you sure to save?". Select Yes button and press OK key to save, or select NO button and press OK key to exit without saving.



1.2 Radio Channel List

Same operation as 1.1 TV Channel List, here we don't explain any more.

1.3 Delete channels by satellite

Press OK key to pop up delete channels by satellite window, press PR+,PR- key to select the programs, and press OK key to add delete mark, press OK again the delete mark will disappeared. Press red key to select all programs to add delete mark, press yellow key to pop up the dialogue:"Warning, Do you really want to delete all channels". Select Yes button and press OK key to save, or select NO button and press OK key to exit without saving.



2. Installation

1. Press OK key or ∇ key to pop up the "Input Password" dialogue, you can not enter into the menu unless the correct password is inputted. The default password is "0000".

2. Press PR+, PR- keys to move the cursor up or down.

3. Press EXIT key or \triangleleft key to move the focus to the left menu.



2.1 Antenna Connection

Press \triangleleft ∇ keys to select between Motor Antenna and Fixed Antenna.



MENU INFORMATION

2.2 Satellite List

1. Press PR+, PR- keys to select the satellite up or down. Press OK key to select and mark, and you can press OK key again to cancel the selection and the mark.

2. If there is no satellite, the red colour and blue colour keys will be invalid.

3. Press red colour key to pop up the Edit Satellite window. Press PR+, PR- keys to move cursor up or down.

Name: User numeric keys to change the name of the satellite, please refer to the Edit Channel Name.

Longitude: You can press \rightarrow \leftarrow keys to switch between east longitude and west longitude. After pressing OK key, you can use numeric keys to edit the longitude, press EXIT key or the PR+, PR- keys to exit editing mode. The range of the longitude is from 1 to 180 degree. If beyond this range, system will inform you "out of range" when you press yellow colour key on the RCU.

After setting, press yellow colour key to save and exit, while press blue colour key to exit without saving.

4. Press green colour key to pop up the Add Satellite window. Since the same operation as the above Edit Satellite window, here we don't explain any more.

5. Press blue colour key to pop up the dialogue "Are you sure to delete?". Select Yes button and press OK key to delete the selected satellite. You can cancel this operation by pressing OK key at the NO button.

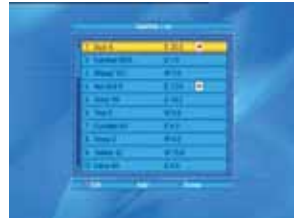

MENU INFORMATION

2.3 Antenna Setup

Part A : Fixed

Suppose that you have selected Fixed Antenna in the Antenna Connection window.

1. Satellite: All selected satellites in the satellite list are displayed in this item.

Press \leftarrow keys to select the satellite in circle. Or press OK key to pop up the drop-down list, then select the desired satellite in the list and press OK key to confirm.

2. LNB Freq, Transponder, DiSEqC1.0, DiSEqC1.1: The same operation as the above.

3. 22K, Polarity: You can press \leftarrow keys to select in circle.



Part B : Motor

Suppose that you have selected Motor Antenna in the Antenna Connection window.

1. LNB T type: Select the proper LNB type.

2. Motor T type: Select between DiSEqC1.2 and USALS. If you select DiSEqC1.2, the following Local Longitude and Local Latitude items will turn grey.

3. Delete All: Press OK key to pop up the dialogue "Are you sure to clear set satellite position of this tuner?". Press OK key at the Yes button to clear all the memories about the position of the satellites that are connected to the current tuner.

4. Motor Setting: Press OK key to the Motor Setting window.

Satellite: Press \leftarrow keys to select the satellite in circle. Or press OK key to pop up the drop-down list, then select the desired satellite in the list and press OK key to confirm.

Transponder: The same operation as the above.



MENU INFORMATION

Position No., & Save: The range is from 0 to 63. "0" delegates the original position. You can select the proper value when you has rotated the antenna.

Go to X: Press OK key to pop up the drop-down list, select the proper position (reference or from 1to 63) to realize the selected position.

West <Save> East: Press \leftarrow key to turn west, while press \rightarrow key to turn east. Press OK key to pop up the dialogue "Are you sure to change this satellite's position?". Press OK key at the Yes button to save the current position, or press OK key at the No button to cancel the operation.

Recalculation: Press OK key to pop up the dialogue "Are you sure to change this satellite's position?". Press OK key at the Yes button to recalculation.

5. Limit Setup: Press OK key to pop up the Limit Setup window.

Limit Setup: Press \leftarrow \rightarrow keys to switch among Disable Limit, East Limit and West Limit.

Limit Setup: Move cursor to the Limit Setup button. You can press \leftarrow key to turn west , or press \rightarrow key to turn east.

Go to Reference: Press OK key to go to reference. If you select Disable Limit in the above Limit Setup item, this button will turn grey.



6. If select USALS, Delete All item will turn grey.

Local Longitude, Local Latitude: Press \leftarrow \rightarrow keys to switch between West and East, or press \leftarrow \rightarrow keys to switch between North and South. Press OK key to enter into the editing mode. Use numeric keys (0-9) to input the longitude or latitude, press MENU key or EXIT key to exit. The range of the longitude is from 0 to 180, while the range of the latitude is from 0 to 90. If the inputted value is not in this range, system will pop up a dialogue "Out of Range" when you exit from this window. You can press OK key to close this dialogue.



MENU INFORMATION

7. Motor Setting : Press OK key to enter into the Motor setting window.

Satellite, Transponder: Press \leftarrow \rightarrow keys to select satellite or transponder, or press OK key to pop up the drop-down list and select in the list.



2.4 Single Satellite Search

1. Satellite : Press \leftarrow \rightarrow keys to select the satellite in circle. Or press OK key to pop up the drop-down list, then select the desired satellite in the list and press OK key to confirm.

2. FT A Only: Press \leftarrow \rightarrow keys to select between Yes and No.

3. Scan Channel: Press \leftarrow \rightarrow keys to select among TV+Radio, TV Channel, Radio.

4. Network Search: Select between No and Yes. This item turns grey when Auto Scan is selected in the following Scan mode item.

5. Scan Mode: Press \leftarrow \rightarrow keys to select between Auto Scan and Preset Scan. Auto Scan is Blind scan, while Preset Scan is to search the preset frequencies.

6. Search: Press OK key to start searching.



2.5 Multi Satellite Search

From the Multi Satellite Search window, you can search several satellites at the one time.

1. Satellite : All selected satellites in the satellite list window are displayed on the down part. You can press \leftarrow \rightarrow keys to switch among them.

2. FT A Only: Press \leftarrow \rightarrow keys to select between Yes and No.

3. Scan Channel: Press \leftarrow \rightarrow keys to select among TV+Radio, TV Channel, Radio.



MENU INFORMATION

4. Network Search: Select between No and Yes. This item turns grey when Auto Scan is selected in the following Scan mode item.
5. Scan Mode: Press \leftarrow \rightarrow keys to select between Auto Scan and Preset Scan. Auto Scan is Blind scan, while Preset Scan is to search the preset frequencies.
6. Search: Press OK key to start searching.

2.6 TP List

1. Press PR+,PR- keys to select the proper satellite.



2. Press red colour key to pop up the Edit TP window.

Frequency, Symbol rate: Press \leftarrow \rightarrow keys to add or reduce by step one. Or press numeric keys (0-9) to input the desired value. The range of the frequency is 3000-13500, while the range of the symbol rate is 1000~45000. The inputted value is beyond this range, the value will return to the origin value.



Polarity: Press \leftarrow \rightarrow keys to switch between Vertical and Horizontal.

3. Press green colour key to pop up the Add TP window. Since the same operation as the above Edit TP window, here we don't explain any more.



MENU INFORMATION

4. Press yellow colour key to pop up dialogue "Are you sure to delete?". Press OK key at the Yes button to delete the selected TP, or press EXIT key to cancel the operation.



5. Press blue colour key to pop up the TP Search window.

FTA only, Scan Channel, Network Search:
Press \leftarrow keys to select the proper option.
Press OK key at the OK button to start searching.



3. System Setup

1. Press OK key or \rightarrow key to move the cursor to the right menu.
2. Press PR+, PR- keys to move the cursor up or down.
3. Press EXIT key or \leftarrow key to move the focus to the left menu.



3.1 Language

1. Press OK key to enter into the Language window. Press \leftarrow keys to select the language in circle, while press PR+, PR- keys to move the cursor up or down in circle.
2. Press MENU key or EXIT key to save and exit.
3. The types of the language, please refer to the configuration of the customer.



MENU INFORMATION

3.2 TV System

Press PR+, PR- key to move the cursor up or down, while press \leftarrow \rightarrow keys to change the setting and the setting will take effect immediately.

1. Display Mode: Select among 1080p_50, 1080p_60, 720p_60, 720p_50, 576p, 576i, 480p, 480i, By Native TV and By source.



2. Aspect Mode: Select among 4:3LetterBox, 4:3PanScan, 16:9 and Auto.

3. Video Output: Select between RGB and YUV.

4. RF System: Select among P AL-BG, P AL-I, P AL-DK and NTSC

5. RF Channel: PAL: 21-69, NTSC: 14-83.

6. Digital Audio Out: Select between LPCM Out and BS Out.

3.3 Display Setting

1. Brightness: Press \leftarrow \rightarrow key to select from 0-100.

2. Contrast: Press \leftarrow \rightarrow key to select from 0-100.

3. Saturation: Press \leftarrow \rightarrow key to select from 0-100.

4. Hue: Press \leftarrow \rightarrow key to select from 0-100.

5. Sharpness: Press \leftarrow \rightarrow key to select from 0-10.



3.4 Local Time Setting

1. Summer Time: Select between ON and OFF. "OFF" delegates the normal time. If select ON, time will add one hour.

2. GMT Offset: When select "ON" in GMT Usage item, system will get the date and time information from the screen automatically. Date and Time two items will turn grey. Select the proper option in the GMT Offset item. The default setting is GMT ON.

3. Date, Time: When select "OFF" in GMT Usage, Date and Time two items take effect, while GMT Usage turns grey. Use numeric keys to input the desired value.5. After setting, press MENU key or EXIT key to exit and save. If the value is invalid, system will inform "Invalid input! Continue to edit?". Press OK key at the Yes button to continue the modification, or press OK key at the No button to exit without saving.



MENU INFORMATION

3.5 Timer Setting

If there is no program, you can not enter into this window. There are 8 timers that can be set. Select Timer up or down, and press OK key to enter into the setting window.

1. Timer mode: The default mode is off. You can set the timer once, daily and off.

2. Timer Service: Select between Channel or Record. If Channel is selected, the Wakeup Channel is displayed in the following item. If Record is selected, the Wakeup Message is displayed in the following item.

3. Wakeup Date, On Time: Use numeric keys to input the valid date.

Duration: Set the gap time. After waking up, system will power off automatically after the duration time.



3.6 Parental Lock

Before entering into the Parental Lock window, you need input the correct password. The default password is 0000.

1. Menu Lock: Press \leftarrow \rightarrow keys to select between Off and On. If select "On", you can not enter into the window before entering the password.

2. Channel Lock: Press \leftarrow \rightarrow keys to select between Off and On. The default value is Off.

If select "On", you can not view the locked channel set in Chanel List Edit window until you have inputted the correct password.

3. New Password: User numeric key (0-9) to input the new password.

4. Confirm Password: Input the new password once again. Confirm password must be the same as the New password. System will inform you "Change password successfully!" while they are the same, or inform you to input the password of Confirm password once again when they are not the same.



MENU INFORMATION

3.7 OSD Setting

1. OSD Timeout: Press \leftarrow \rightarrow keys to select from 1 to 10 by step 1. The default values is 5.
 2. OSD Transparency: Press \leftarrow \rightarrow keys to select among Off, 10%, 20%, 30%, 40%. The default option is Off.
- Press MENU or EXIT key to save and exit.



3.8 Favorite

There are 32 favorites group listed in this window. Press PR+, PR- keys to select one and press OK key to the Rename window. Since the same operation as the above the Add Satellite window, here we don't explain any more.



3.9 Other

1. LNB Power: Select between Off and On.
2. Channel Play Type: Select among All, Free, Scramble.
3. Channel Change: Select between Black Screen and Freeze.
4. Auto Standby: Select between On and Off..



4. Tools

1. Press OK key or \rightarrow key to pop up the "Input Password" dialogue, you can not enter into the menu unless the correct password is inputted. The default password is 0000.
2. Press PR+, PR- keys to move the cursor up or down.
3. Press EXIT key or \leftarrow key to move the focus to the left menu.



4.1 Information

Press OK key to the Information window.

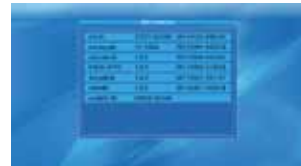

MENU INFORMATION

4.2 Factory Setting

Press OK key to enter into the Factory Setting window.

Select Yes button and press OK key to return to the factory setting. All searched channels and set information will be erased.

Select No button and press OK key to cancel this operation, or press MENU or EXIT key to cancel and exit.



4.3 Conditional Access

Insert the smart card with the golden chip facing down. Push the smart card into the CA slot. Only a few millimetres of the card should be visible outside the slot.

Select Conditional Access item and press OK key, then you will enter into its sub-menu which consists four items of About CA Info, Change PIN, Change Signature PIN, Maturity Level.

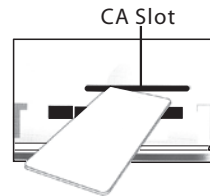

4.3.1 About CA Info

In About CA Info sub-menu, you can know the basic information about this conditional access such as Card Status, CAS System ID, Interface Version, Card Number, Number of sessions, Country Indicator, and Maturity Level.



4.3.2 Change PIN

Changes PIN window is designed for changing the smart card's PIN, which is required if you want change the maturity level settings.

In order to change the PIN, you must know the current PIN also called the old PIN. Input the new PIN and twice the PIN (New PIN and Confirm PIN must be the same) your want to set. Move cursor to OK button and press OK key, and then system will pop up a dialogue informing you the changing result.



Note that the PIN can only constructed with Arabic numerals.

4.3.3 Change Signature PIN

Do the same way as the above Change PIN.

Note: The signature PIN will be locked after the three erroneous attempts to enter the correct PIN. If locked, please call the dealer for help.

MENU INFORMATION

4.3.4 Maturity Level

Input the PIN then Move cursor to Select Maturity level,you can select A-Over18,X-Erotic,G-General audience,PG-Parental Guidance,move cursor to Change Maturity level button and press OK key,and then system will pop up a dialogue informing you the changing result.

4.3.5 Subscription Status

Know the detail information of Subscription Status.

4.3.6 Even Status

Know the detail information of Event Status.

4.3.7 T oken Status

Know the detail information of T okens Status.

4.4 Upgrade by USB

1.Upgrade File: Show the Upgrade File.

2.Upgrade Mode: Select between allcode, maincode, defaultdb, userdb and Dump. When users switch the upgrade mode, “Upgrade File ” will show the corresponding file according to the table below:

Upgrade Mode	File feature
All code :	File named as "*.abs"
Main Code:	File named as "*.abs"
userdb:	File named as "*.abs", the picture will be used as both radio back and menu back
Default db:	File named as "*.abs"



Select the upgrade mode and upgrade file, then you can start upgrade by USB.

3.Press OK key on start button to start receiving the data from USB device.

When the USB device is not connected, this item is grey, you can not edit it now.

4.5 Network Local Setting

DHCP: Select between ON and OFF, when it ON, the IP Address, Subnet Mask and Gateway item will turn gray, you can not edit them.



Press number 0-9 the input the address.

4.6 WiFi Manager

Insert Wifi equipment first, then search available Enter net signal , input the password to connect with network.

MENU INFORMATION

4.7 Upgrade by Network

1. Protocol: Select between HTTP and FTP .
2. URL Type: Select between number and string.
3. URL: press number key 0-9 to input.
4. User: Press number key 0-9 to input the user name.
5. Press number key 0-9 the input the password.
6. Press OK key on star button to begin updating
Press green key to delete the number or characters
and press red key to switch the input mode.



4.8 Weather Forecast

- Press green key to add city
- Press yellow key to delete city
- Press red key to update





4.9 RSS Reader

- RSS Channel list is on the left side of window
- RSS News list is on the right side of window
- Press PR+, PR- key to select channel you wanted
- Press red key to update
- Press green key to add channel
- Press yellow key to delete channel
- Press blue key to edit channel



5. Game

1. Press OK key or  key to enter into the game.
2. Press PR+, PR- keys to move the cursor up or down.
3. Press EXIT key or  key to move the focus to the left menu.
4. Select the game that you want to play and press OK key to enter into the window.



6. REC

6.1 Media Player

USB menu will be automatically shown when insert U disk to USB port except auto scan, multi picture, upgrade. Or open USB menu according to Menu -> REC->Media Player. Press OK to enter into this window.

USB menu will be disabled when no USB device is plugged. Media Play List will not be saved when USB plug out or standby or power off.



Move scroll bar when press up/down key, page up or down by page key. Go into sub-directory when press ok key in the file directory, play the selected file when scroll bar is on the file, automatic return USB menu after play is over.



MENU INFORMATION

In edit window:

Red key: Press red key to enter the rename window, you can rename the file by press number 0-9 on RCU.

Green key: Press green key to enter the copy window, press   key to select the place you want to copy to, and press green key to begin copying.

Yellow key: Press yellow key to add the delete symbol on your selected file, press yellow key again

the symbol will disappeared. Press OK key on the file with delete symbol, it will pop up a dialogue: " Are you sure to delete ?" Select YES to delete and select NO to quit without delete the file. and press EXIT key to quit without delete the file.

Blue key: Press blue key to enter the New Folder window , you can press number 0-9 to edit.

In music list

Press number key 1 to display the Sort window.

Press number key 2 to select the repeat mode.

The function of colour key is the same as Color key operation

In video list

Press number key 1 to display the Sort window.

The function of colour is the same as Color key operation

In record list

Red key: Press red key to enter the rename window, you can rename the file by press number 0-9 on RCU

Green key: Press green key to lock the file you selected

Yellow key: Press yellow key to delete the file you selected.

6.2 PVR Storage Information

Show you the information in windows as besides.

Yellow key: Press yellow key to format the disk

Blue key: Press blue key to pop up DVR Set windw.



MENU INFORMATION

6.3 PVR Setting

1. Time shift: Select between Off and On.
2. Jump: Select among 30sec,1min, 5mi,10min,30min.
3. Timeshift to Record: Select between On and Off.



6.4 Remove USB device safely

Press OK on this item it will pop up a dialogue: "You can safely remove USB device now!", then you can move your USB device safely.

7. Hot Key

7.1 Info

Press INFO key to pop up the Info bar.

Press INFO key again to pop up the program guide of the current program.



7.2 EPG

Press EPG key to enter into the EPG window.

1. Press PR+, PR-, \leftarrow \rightarrow keys to select up or down, left or right.

2. Press red colour key to pop up the Time Bar window. Press PR+, PR- keys to select up or down, while press \leftarrow \rightarrow keys to select left or right in the time bar.

\leftarrow : Press OK key at this button to return to the EPG window.

\uparrow : Press OK key at this button to move the cursor to the current time line.

$\blacktriangleleft \blacktriangleright$: Press OK key to push the time forward or backward by half an hour.

$\blacktriangleleft \blacktriangleleft \blacktriangleright \blacktriangleright$: Press OK key to push the time forward or backward by half an hour.

$\blacktriangleleft \blacktriangleleft \blacktriangleright \blacktriangleright \blacktriangleright \blacktriangleright$: Press OK key to push the time forward or backward by a day.

3. Detail Information: In the EPG window, press PR+, PR- \leftarrow \rightarrow keys to select the channel and program, and press OK key to know the detail information of the current program.

4. Press green colour key to enter into the Timer window. You can add the current program to the Timer. If 8 timers are already yet, system will inform you "Timer is full!".



MENU INFORMATION

7.3 Find

Press FIND key on to pop up the Find window. Use numeric keys to enter into the character and use the colour keys to realized the corresponding operation.



7.4 Number

Use the numeric keys (0-9) to input the number of the desired channel. If the inputted number is beyond the valid channel number, system will "No such a channel" and press OK key to close this message.

7.5 TV/RADIO

In normal mode, press TV/RADIO key to switch between TV mode and Radio mode.

7.6 Up/Down (Channel Change)

Press PR+, PR- keys to change the channel up or down. If in the all satellites group, you can select channel in all searched channels. If in the specific satellite, only can select channel in the satellite group.

7.7 Left/Right (Volume+/-)

Press \leftarrow keys to change the volume. Press \rightarrow keys to decrease the volume, while press \leftarrow keys to increase the volume.

7.8 Mute

Press \times key to turn off the volume. You can press \times key once again to restore the volume, or press \rightarrow keys to increase the volume.

7.9 Pause

During the viewing, you can press PAUSE key to stop the picture while the volume continues. You can play the picture by pressing PAUSE key once again.

7.10 OK

1. During the viewing or listening, press OK key to pop up the TV program list or the Radio program list.
2. Press PR+, PR- keys to select the channel up or down, and then press OK key to play this channel in full-screen.
3. Press \leftarrow keys to select the satellite.
4. Press MENU or EXIT key to close this window.



MENU INFORMATION

7.11 Audio

1. Press **OK** keys to enter into the Audio window.
2. Press **Left** / **Right** keys to select among Left, Right, Stereo, and Mono.
3. Changing the audio mode is only connected with the current channel, not all the channels.
4. Press **MENU** or **EXIT** key to close this window.



7.12 Recall

Press **Left** key to switch the current channel to the previous channel.

7.13 FA V

1. Press **FAV** key to pop up the favourite group window.
2. Press **Left** / **Right** keys to select the favorite group.
Press **PR+**, **PR-** keys to select the channel up or down. Press **OK** key at the selected channel to view it in full-screen. Press **MENU** or **EXIT** key to exit.
3. If there is no favorite channel, system will inform "No FA V Channell!" when you press **FAV** key.



7.14 T eletext

Press **TXT** key to open the teletext on the screen. If there is no teletext, system will inform "No Teletext Data". Press **EXIT** key to exit.

TROUBLE SHOOTING

Problem	Possible causes	What to do
The display on the front panel does not light up.	Main cable is not connected.	Check that the main cable is plugged into the power socket.
No sound or picture, but the front panel shows red light.	The receiver is in standby mode.	Press the standby button.
No sound or picture.	The satellite dish is not pointing at the satellite.	Adjust the dish. Check the signal level in the Antenna Setup menu.
	No signal or weak signal.	Check the cable connections, LNB and other equipment connected between the LNB and the receiver, or adjust the dish.
	The satellite dish is not pointing at the satellite.	Adjust the dish.
	Signal is too strong.	Connect a signal attenuator to the LNB input.
Bad picture / blocking error.	Satellite dish is too small.	Change to a larger dish.
	LNB noise factor too high.	Change to an LNB with lower noise factor.
	The LNB is faulty.	Change the LNB.
The picture is not showed on the screen, when switching on.	The system is connected by RF leads.	Check the UHF channel fixed in your system and tune the UHF channel properly.
There is interference on your digital satellite channels, an existing terrestrial channel or video signal.	The system is connected by RF leads and the output channel of the receiver interferes with an existing terrestrial channels or Video signal.	Change the receiver output channel to a more suitable channel, or connect the system by SCART leads.
The RCU is not working.	Battery exhausted.	Change the batteries.
	RCU is incorrectly aimed.	Aim RCU at the receiver, or check that nothing blocks the front panel.

- Note : If you have tried all of the actions suggested above, without solving the problem, please contact your dealer or service provider.

